

# **GK INDICATOR**

(P.N. 305669264, Revision K1, July 2011)

V1.17 GK-H scales for Europe

V2.25 EC Approved scale

V3.32 GK scale for Europe

V4.07 GK-H scale for USA

V5.32 GK scales for USA

**Easy Reference:**

Model name of the indicator:	
Serial number of the unit:	
Software revision number (Displayed when power is first turned on):	
Date of Purchase:	
Name of the supplier and place:	

## CONTENTS

1. INTRODUCTION .....	3
2. SPECIFICATIONS.....	5
3. INSTALLATION .....	7
3.1. UNPACKING.....	7
4. LOCATING.....	7
5. CONNECTION.....	8
6. DISPLAY .....	11
6.1. SYMBOLS AND INDICATORS.....	11
7. CALIBRATION COUNTER FOR APPROVED INDICATORS .....	12
8. BATTERY.....	14
9. BACKLIGHT.....	14
10. AUTO POWER OFF .....	14
11. OPERATION .....	15
11.1. ZEROING .....	15
11.2. TARING.....	15
11.2.1 MANUAL TARE.....	15
11.2.2 PRESET TARE (NOT AVAILABLE ON GK-M APPROVED INDICATORS).....	16
11.3. WEIGHING.....	17
11.4. PARTS COUNTING .....	17
11.5. CHECK-WEIGHING .....	20
11.5.1 SETTING UP WHILE WEIGHING.....	21
11.5.2 SETTING UP WHILE PARTS COUNTING OR % WEIGHING	22
11.6. LIMITS STORING AND RECALLING.....	22
11.7. PERCENT WEIGHING.....	24
11.8. ANIMAL (DYNAMIC) WEIGHING.....	27
11.8.1 ANIMAL WEIGHING PROCEDURE.....	28
11.9. ACCUMULATED TOTAL.....	29
11.9.1 MANUAL ACCUMULATION.....	29
11.9.2 AUTOMATIC ACCUMULATION.....	31
12. RS-232 SPECIFICATION.....	32
12.1. INPUT COMMANDS FORMAT .....	37
13. CALIBRATION.....	38
14. PARAMETER SETTINGS .....	39
14.1. CHECK WEIGHING PARAMETERS .....	39
14.2. RS-232 PARAMETERS .....	42
14.3. INDICATOR PARAMETERS.....	44
14.4. PERCENT WEIGHING AND ANIMAL WEIGHING.....	46
15. ERROR MESSAGES .....	47
16. SERVICE PARAMETERS.....	49
16.1. ACCESS TO PARAMETERS.....	49

<b>16.2.</b>	<b>USING “2006” TO ENTER THE SERVICE PARAMETERS .....</b>	<b>50</b>
16.2.1	F1 -CALIBRATION .....	52
16.2.2	F2-DECIMAL POINT POSITION .....	53
16.2.3	F3 – CAPACITY .....	53
16.2.4	F4 –INITIAL ZERO RANGE .....	54
16.2.5	F5 -RE-ZERO RANGE .....	54
16.2.6	F6 -SUCCESSIVE TARE .....	55
16.2.7	F7 –ADC COUNTS.....	55
16.2.8	F8 –ZERO MODE.....	56
16.2.9	F9 –LOW VOLTAGE DETECTION .....	56
16.2.10	F10 –CALIBRATION COUNT (GK-M ONLY).....	57
16.2.11	F10 –AUTO ZERO RANGE (NOT AVAILABLE ON GK-M) ....	57
<b>17.</b>	<b>REPLACEMENT PARTS AND ACCESSORIES .....</b>	<b>58</b>
<b>18.</b>	<b>SERVICE INFORMATION.....</b>	<b>59</b>
<b>19.</b>	<b>APPENDIX .....</b>	<b>61</b>

## 1. INTRODUCTION

- The **GK** indicator provides an accurate, fast and versatile general purpose indicator with parts counting, percent weighing and check-weighing functions.
- The **GK** has LEDs to indicate when a weight is below the low limit, between the limits or above the high limit next to the display. These can work in conjunction with an audible alarm for check weighing as well as LCD showing LO, OK and HI.
- The **GK** is supplied with a RS-232 bi-directional interface and real time clock (RTC).
- The **GK** has a sealed keypad with colour coded membrane switches and a large easy to read liquid crystal type display (LCD) supplied with a backlight.
- Includes automatic zero tracking, semi-automatic & pre-set tare, accumulation facility that allows the weight to be stored and recalled as an accumulated total.
- **OIML Approved models, GK-M**, do not allow pounds units, have calibration controlled by jumpers or passcodes and other limitations as noted in the manual.



## 2. SPECIFICATIONS

INPUT SECTION	
Load Cells	Up to 4 , 350 ohm load cells Minimum 87 ohms, maximum 1120 ohms
Connection	6 wires 2 excitation, 2 sense, 2 signal
Excitation	5Vdc
Sensitivity	0.15uv/d (GK-M, 1.5uv/e)
Linearity	0.01% FS
Zero Range	0- 10mv
Signal range	0-40mv
ADC Sensitivity	Approximately 0.02 $\mu$ v/ADC count
DIGITAL SECTION	
Maximum Range	Typically 1kg – 30000kg
Divisions	Up to 30,000, (GK –M, 3000 or less)
Weigh units	kg / g for Europe, Asia, Africa kg / g / lb / oz / lb:oz for USA kg only for GK-M series
Stabilisation Time	2 Seconds typical
Operating Temperature	-10°C - 40°C 14°F - 104°F
Power supply	230 VAC 50/60 Hz 12V 800ma adaptor for USA verisons
Battery	Internal rechargeable battery
Calibration	Automatic External
Display	6 digits LCD digital displays with capacity tracker and symbols for units
Indicator Housing	ABS Plastic
Overall Dimensions (wxdxh)	260 x 170 x 115mm 10.2" x 6.7" x 4.5"
Net Weight	2 kg / 1 lb
Applications	Weighing and check weighing
Functions	Weighing, Check Weighing, Parts counting, check-counting, , Animal Weighing, Accumulating memory,
Interface	RS-232 bi-directional interface English, German, French, Spanish selectable text

For approved indicators the input specifications is limited to 1.5  $\mu$ v per division and the number of divisions is limited to 3000d. Kilograms only.





### 3. INSTALLATION

#### 3.1. UNPACKING

This indicator must be connected to a load cell platform and calibrated as necessary to match the platform and user requirements. See Section 15 for set-up information.

The users application and the technical specifications of the platform or load cell will determine the necessary configuration.

#### 4. LOCATING



- The scales should not be placed in a location that will reduce the accuracy.



- Avoid extremes of temperature. Do not place in direct sunlight or near air conditioning vents.

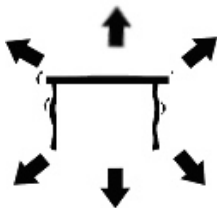

- Avoid unsuitable tables. The table or floor must be rigid and not vibrate.

- Avoid unstable power sources. Do not use near large users of electricity such as welding equipment or large motors.



- Do not place near vibrating machinery.

- Avoid high humidity that might cause condensation. Avoid direct contact with water. Do not spray or immerse the scales in water.

- Avoid air movement such as from fans or opening doors. Do not place near open windows or air-conditioning vents.

- Keep the scales clean. Do not stack material on the scales when they are not in use.

## 5. CONNECTION

This indicator must be connected to a load cell platform and calibrated as necessary to match the platform and user requirements.

The GK has a connector configured for a 6 wire load cell. Connect the load cells/platform to the indicator as shown below. The cable length should be as short as possible, using a large size wire to minimise errors due to resistance in the leads.

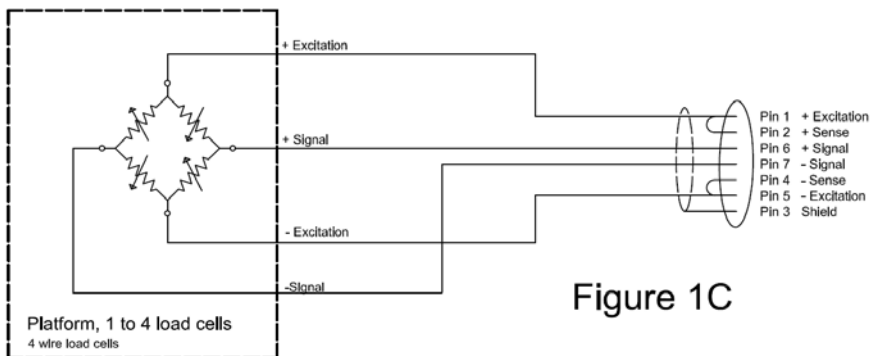
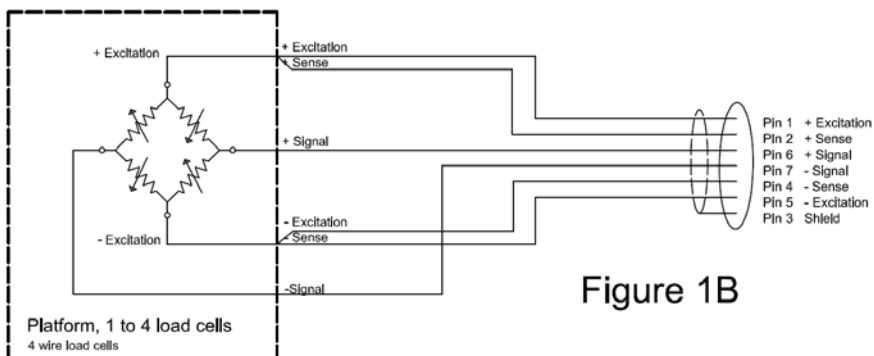
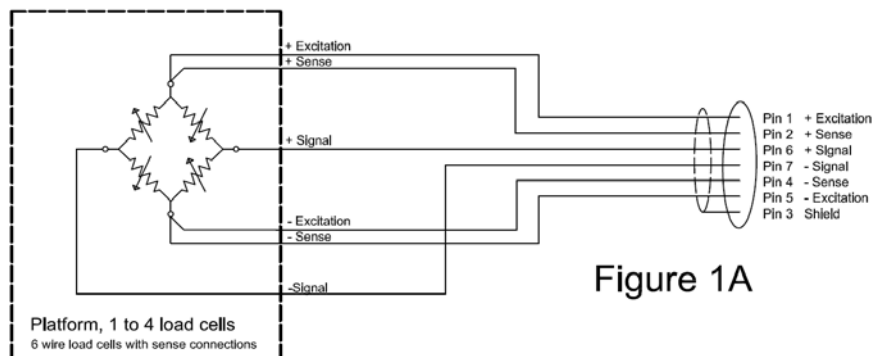

GK-M model must use the 6 wire connection and has certain limitations for wire size and length. Refer to the Approval Test Certificate for details.

Figure 1A shows the connections to a 6 wire load cell. Figure 1B shows a preferred method to attach a 4 wire load cell, using a 6 conductor cable to go from the indicator to the platform or load cell where it connects to the 4 wires from the load cells. The Excitation and sense wires are connected together near the load cell.

For less exacting applications you can connect the excitation to the sense at the connector.

**KEYPAD**

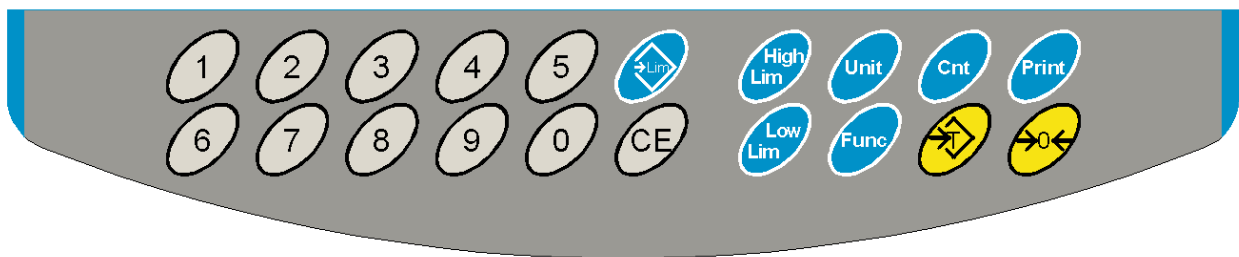

KEYS	PRIMARY FUNCTION	SECONDARY FUNCTION
[Zero]	Sets the zero point for all subsequent weighing. The display shows zero.	Escape from any setting menus
[Tare]	It tares the indicator and stores the current weight in memory as a tare value, subtracts the tare value from the weight and shows the results. This is the net weight.	Accept the set values
[Unit]	This is used to select the weighing units from a preset list of available units.	Allows the weight, unit weight, and count to be seen when parts counting or to change from weight to % in percent weighing

<b>[Low Limit]</b>  <b>&amp;</b>  <b>[High Limit]</b>	It sets the limits for check weighing and allows setting of either the low limit or the high limit or both.	None
<b>[→Lim]</b>	It stores and recalls any of 10 preset limits	None
<b>[Func]</b>	This is used to select percent weighing, RS-232 parameters, Operation of the bar graph, RTC settings, User ID and Scale ID.	None
<b>[Count]</b>	Enter Parts Counting	None.
<b>[Print]</b>	It is used to print the results to a PC or printer using the RS-232 interface. It also adds the value to the accumulation memory if the accumulation function is not automatic.	None
<b>[1] to [0]</b> <b>and [CE]</b>	Allow entering numerical values where required, setting of limits, tare value, time and date for example.	

## 6. DISPLAY

### 6.1. SYMBOLS AND INDICATORS

The LCD has unique symbols to indicate the following:

→0←

The display is at Zero



The scale is Stable

Net

Net weight- The scale has been tared

kg / lb

Symbols shown for the units

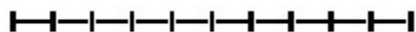

Capacity Tracker- A bar graph indicating the proportion of the scale capacity being used by the weight on the pan

bAt LO or 

Low battery

%

The scale is in Percent weighing mode

pcs

The scale is in Parts counting mode

HI, OK, LO

The scale is in Check weighing mode

:

The colons “:” are used to separate pounds from ounces and for the real time clock.

Next to the LCD are a number of LED's that show when the weight is below, within or over the limits during check weighing.

<b>Weight</b>	<b>LED</b>	<b>LCD</b>
below the low limit	Amber	LO
Within the limits	Green	OK
Above the high limit	Red	HI

NOTE: The LED's can be set by the user to off, bar, spot or segment mode. See "**F3 LED**" in section 13.1

The LED can be set to display as a bar, increasing from Low to OK to High, a single spot increasing from Low, OK to High, or as a single bar that changes colour as the weight progresses from Low to OK to High.

## **7. CALIBRATION COUNTER FOR APPROVED INDICATORS**

With approved (GK-M Model) indicators we have the ability to control access to the calibration or metrology parameters using a passcode to limit access. The requirements for doing this stipulate the code should be apparent and recorded in a suitable location on the indicator.

In this way if the record of the Calibration or Parameter counters do not agree with recorded settings the responsible person inspecting the indicator can take appropriate action.

The Counters are incremented any time the calibration section or the Factory parameters section have been modified.

At power on, the display will show the current software revision number followed by the message of the Calibration Count “[AL[nt” then a number i.e. “123”. The number from the counter memory. Then the Parameter Counter message of “[PAr[nt” and probably a different number, i.e. “234”. The counters cannot be reset to 0, they will increment until the display can no longer hold the values. (1 to 999999). It is expected we will never have more than 1 million calibrations in the life of the machine.

Each display is held for 1-2 seconds.

The indicator will then continue to do the display test and go to normal weighing.

If during the time the counting displays are shown, the user presses the [Tare] key, the user will be given a message to enter the passcode necessary to calibrate the indicator, “P - - - “ Enter the code “P0000” to Enter calibration or “P1000” to enter the parameters, followed by pressing the [Tare] key.

The Calibration access will allow user calibration (See section 15.1) and the parameter code will allow access to the following parameters. (see section 15.2).

“F4 Int”	Initial Zero Range
“F5 rEZ”	Re-Zero range
“F6 SCS”	Successive Tare Enable
“F7 Cnt”	Display ADC counts
“F8 Zem”	Zero Mode
“F9 Lvd”	Low voltage detection

Other parameters must be changed using the service parameters as described in section 15.2

## 8. BATTERY

- The indicators can be operated from the rechargeable battery, if desired. The battery life is determined by the number and impedance of the load cells connected. With a single load cell and backlight disabled the life is approximately 70 hours before needing to be recharged.
- When the battery needs charging a symbol on the display will turn on. The battery should be charged when the symbol is on. The indicator will still operate for a period of time after which it will automatically switch off to protect the battery.
- To charge the battery, simply plug into the mains power supply. The indicator does not need to be turned on.
- The battery should be charged for 12 hours for full capacity.
- To the right of the display is a LED to indicate the status of battery charging. When the indicator is plugged into the mains power the internal battery will be charged. If the LED is green the battery is being charged. If it is red it is nearly discharged and yellow indicates the battery is increasing the charge level. Continue to charge overnight for a complete re-charge.

## 9. BACKLIGHT

The backlight for the LCD can be set by the user to always off, always on or automatic (on only when the indicator is in use or a key is pressed). See setting of the parameter "**S2 bl**" in section 14.3.

## 10. AUTO POWER OFF

The auto power off can be set by the user to disable the feature or to a pre-set time interval. See setting of the parameter "**S3 AoF**" in section 14.3.



## 11. OPERATION

### 11.1. ZEROING

- You can press the **[Zero]** key at any time to set the zero point from which all other weighing and counting is measured. This will usually be necessary when the platform is empty. When the zero point is obtained the display will show the zero indicator.



- The indicator has an automatic re-zeroing function to account for minor drifting or accumulation of material on a connected platform. However you may need to press **[Zero]** to re-zero the indicator if small amount of weight is still shown when the platform is empty.

### 11.2. TARING

#### 11.2.1 MANUAL TARE

- Zero the indicator by pressing **[Zero]**. The zero indicator will be on. Place a container on the pan and its weight will be displayed.
- Press **[Tare]** when the reading is stable. The weight that was displayed is stored as the tare value and it is subtracted from the display, leaving zero on the display. The stable and Net indicator will be on.



- As a product is added only the weight of the product will be shown. The indicator could be tared a second time if another type of product was to be added to the first one. Again only the weight that is added after taring will be displayed.



## **NOTE:**

When the container is removed a negative value will be shown. If the indicator was tared just before removing the container, this value is the gross weight of the container plus all products which were removed. The zero indicator will also be on as the platform is back to the same condition it was when **[Zero]** was pressed last.

If the value to be tared is very large the scale may not allow you to tare the value as the negative value will not fit on the display area. In this case the scale will beep twice when the **[Tare]** key is pressed and then return to normal weighing without setting tare.

Press **[Tare]** or **[Zero]** to remove the tare value and display zero. The Net indicator will disappear.

### 11.2.2      PRESET TARE (NOT AVAILABLE ON GK-M APPROVED INDICATORS)

When the indicator is at zero with no weight on the platform it is possible to enter a preset tare.

- Zero the indicator by pressing **[Zero]**. The zero indicator will be on.
- Enter a value using the numeric keys.
- Press **[Tare]** to tare the indicator. The value that was entered is stored as the tare value and it is subtracted from the display, leaving a negative number on the display.

### 11.3. WEIGHING

To determine the weight of a sample, first tare an empty container if used, then place the sample in the container. The display will show the weight and the unit of weight currently in use.



To change the weighing unit press the **[Unit]** key. The only alternative weighing unit is pounds. This can be enabled by the user in the parameters section. See section 13.3.

### 11.4. PARTS COUNTING

The indicator can be used to count parts based on the average weight of a sample weighed. When more parts are added the total number of parts are displayed.

- If a container is to be used, place this container on the platform before entering parts counting and press **[Tare]**.



- Press **[Cnt]** to enter the Parts Counting mode. The display will show the last sample size used. For example, **"10 Pcs"**.

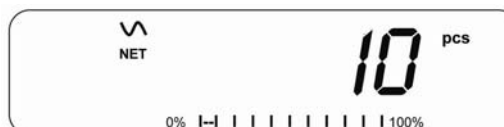

- Either place 10 parts on the platform for determining the average piece weight or use a different number of parts. For example, place 20 parts on the platform, press **[CE]** to clear the last values and then enter the value 20 using the numeric keypad.



- Press **[Cnt]** to weigh the samples and determine an average piece weight.
- If the parts are too light to measure accurately, the count may become faulty. It is suggested that the samples to be weighed should each weigh more than the resolution of the indicator.
- After the sample has been weighed the indicator will count any other parts added by applying the average piece weight to the weight of the parts to be counted.



- The **[Tare]** key works normally during this time, so it is possible to tare the display with a container on the platform or to enter a preset tare value as described in section 10.2.2.
- During parts counting the display can be changed to show the net weight, unit weight and number of parts by each time pressing the **[Func]** key.





- To count a different sample quantity, press the **[Count]** key. The display will show the last used sample size. Either use this sample size with a different part or enter a new sample size as above.
- To return to weighing, press **[Unit]** when **"XX pcs"** is displayed.

## 11.5. CHECK-WEIGHING

Check-weighing is a procedure to display an indicator or sound an alarm when the weight on the platform meets or exceeds the values stored in the memory. The memory holds values for a high limit and a low limit. Either or both the limits can be set by the user.

### NOTE:

1. The alarm and the LED bargraph can each be set to OFF (See section 13.1). The LCD display will indicate whenever the weight is within or exceeds the limits by showing 'OK', 'HI' or 'LO'.

	Mass on the platform is above the high limit
	Mass is between the limits
	Mass is below the low limit

2. The limits can be locked by the manager. A Limit Password must be used to change the limits or recall other limits from memory.
3. If Limit Password is enabled then enter the password which will allow you to change the limits or the operation of the beeper or bargraph.

### 11.5.1 SETTING UP WHILE WEIGHING

- Press the **[Low Limit]** key. It will show the current low limit. The “**LO**” symbol will appear on the display.
- Press the **[CE]** key to clear the old value and then enter the new low limit using the numeric keys. The decimal point is fixed at the position that is used for the current weighing unit. When the desired value is shown press **[Tare]** to accept the value. If you want to reset the value to zero, press **[CE]** to clear the value.
- The limits are displayed in the weighing unit in use.
- To set the high limit press **[High Limit]**, the display will show the high limit, the “**HI**” symbol will be on to the left side of the display. Set the high limit in the same way the low limit was set.
- Pressing the **[Tare]** key to enter the value will return the indicator to weighing, with the Check-weighing function enabled.

## 11.5.2 SETTING UP WHILE PARTS COUNTING OR % WEIGHING

During parts counting and percent weighing the limits are set in the same way as above. The limits are displayed in pcs or %.

See Section 10.4 for the description of parts counting and Section 10.7 for percent weighing.

### **NOTE:**

1. The weight must be greater than 20 scale divisions for the check-weighing to operate.
2. To disable the check weighing function, enter zero into both the limits as described above. When the current limits are shown, press **[CE]** to clear the settings, then press **[Tare]** to store the zero values.

## 11.6. LIMITS STORING AND RECALLING

The indicator can store up to 10 sets of high and low limits in memory along with the weighing units in use (including pcs for parts counting and % for percent weighing) as well as settings for the beeper and bar graph.

During Check weighing the current limits can be stored or previously stored units can be recalled.





Press the [**→Lim**] key. If you are already in the check weighing mode the display will ask if you wish to store the current limits by showing “**StOrE**” or recall another set of limits by showing “**rECALL**”. The [**→Lim**] key can be used to toggle between “**StOrE**” and “**rECALL**”.

If you want to store the limits, when “**StOrE**” is displayed press the [**Tare**] key. The display shows “**St**”. Enter a number corresponding to the desired memory location (0 to 9). “**St X**” will be displayed for 2 seconds indicating the location X where the current limits, weighing units and settings for the beeper and bar graph are stored. The indicator will continue to work with the current settings as active.

If you wish to recall any of the pre-stored limits, press [**Tare**] when “**rECALL**” is displayed. The display shows “**rEC**”. Enter the number corresponding to the desired memory location (0 to 9) to be recalled. “**rEC X**” will be displayed for 2 seconds indicating the values stored in the location “X” is being recalled. The indicator will change to the recalled limits, weighing units and settings for the beeper and bar graph.

**NOTE:**

1. If the recalled limit is for parts counting, the display will show the last sample value used, ready for a new sample to be counted.
2. If the recalled unit is a percent weighing limit, the display will show the last sample value used, ready for a new sample to be weighed.
3. If the memory location was empty the indicator will return to weighing.

**11.7. PERCENT WEIGHING**

The indicator can be set to perform percent weighing. See Section 13.1.

The indicator will use a mass on the platform as the 100% reference weight. If the platform is empty (or the indicator is tared) then the user can input a reference weight using the keypad.

- If using a reference weight (or object) as your 100% reference, add the weight to the to the platform.
- Press [**Func**]. The first option is "**FUnC 1**", press the [**Func**] key 3 more times to display "**FUnC 4**".



- Press the [**Tare**] key. "**F4 Pct**" will be displayed.



- Press [**Tare**] again to enter percent weighing. The indicator will set the sample mass on the platform as 100% reference weight.

**NOTE:** If there is no reference weight on the pan and percent weighing function is entered, pressing [**Tare**] again will return the indicator to normal weighing.



- Remove the sample weight. Then any other weight placed on the platform will be displayed as a percentage of the original sample. For example, if 3500g is placed on the platform and percent weighing is selected, the display will show 100.00%. Remove the 3500g weight and place a 3000g weight. The display will show 85.7% as 3000g is 85.7% of 3500g.



- The number of decimal points will depend on the weight used. A smaller weight will show only “100%” while a larger weight might show “100.00%”.
- If the indicator was showing zero weight before entering this function, then the user must manually enter the weight to be set as 100%. When “F4 PCT” is displayed, enter the weight to be used for the 100% reference, then press [**Tare**] to accept the reference weight. The display will show “0.00 %”.

- If the indicator shows “**x x . x x %**”, which is the last weight used as a reference, press **[CE]** to clear and use the numeric keypad to enter a new value. Press **[Tare]** to accept the new reference weight.
- The weight entered must be greater than 50 scale divisions.
- Press **[Unit]** to return to normal weighing.

**NOTE:**

The display may jump by large numbers unexpectedly if small weights are used to set as 100% reference. The indicator checks if the weight is too small and will show Error 7.

## 11.8. ANIMAL (DYNAMIC) WEIGHING

The indicator can be set to animal (dynamic) weighing for weighing any items that are unstable or may move. See Section 13.4.

The indicator uses a special filter to minimise the effects of any movement on the platform.

- Press **[Func]**. The first option is "FUnC 1", press the **[Func]** key 3 more times to display "Func 4".



- Press the **[Tare]** key. "F4 Pct" will be displayed. Press the **[Func]** key to advance to the second function, "F4 AnL", Animal weighing.

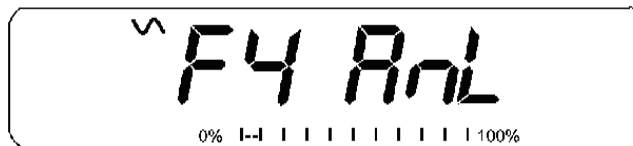

- Press **[Tare]** to enter the animal weighing function.
- To use the Animal Weighing function it is necessary to set the amount of filtering required for the animals to be weighed. More active animals will require a higher level of filtering to give a stable result. The display will show "Filt x" where x is a value from 1 to 5. The higher the value the greater the amount of filter will be. To increment the value shown press the **[Func]** key then press the **[Tare]** key to accept it.
- The display will flash "Ani " 2 times then show the current weight, 0.00. The indicator is now ready to weigh.

### 11.8.1 ANIMAL WEIGHING PROCEDURE

- With the platform empty the display will show zero weight.. Place containers or blankets onto the platform and press the **[Tare]** key to zero the display. The indicator may go into the animal weighing procedure when the items are placed on the platform but will return to showing zero when the **[Tare]** key is
- Place the animal to be weighed on the platform.
- When a stable reading is found, the display will show this value, and the display will be locked until the [Unit] key is pressed. The display will show the “Hold” symbol while the display is locked. Remove the animal, the display will hold the weight value.
- Press the **[Unit]** key to unlock the display. The display will flash “Ani” twice, and be ready for the next animal.
- To weigh a second animal press the **[Tare]** key if necessary to zero the display, and place the next animal on the platform. It is also possible to simply place the next animal on the scale without clearing the last value first. The indicator will detect the new weight and hold it as before.
- The indicator will remain in the animal weighing mode until the **[Zero]** key is pressed. Then it will return to normal weighing.

## 11.9. ACCUMULATED TOTAL

The indicator can be set to accumulate when a weight is added to the platform automatically or manually by pressing **[Print]**. See Section 13.2.

### NOTE:

1. The accumulation function is available only during weighing. It is disabled during parts counting or percent weighing.
2. The accumulated weights will be stored in either kg or lb, depending upon the weighing unit in use.
3. If at any time the weighing units are changed, the accumulated data will be lost.

### 11.9.1 MANUAL ACCUMULATION

When the indicator is set to manual accumulation, the weight displayed will be stored in the memory when the **[Print]** key is pressed and the weight is stable.

- Remove the weight and press **[Print]** when the indicator is at zero. The display will show **"ACC 1"** and then the weight in memory for 2 seconds before returning to normal. The weight can be output to a printer or PC using the RS-232 interface.



- When the indicator is at zero place a second weight on the platform. When stable press **[Print]** to accumulate the weight. The display will show "ACC 2" for 2 seconds and then show the new total.

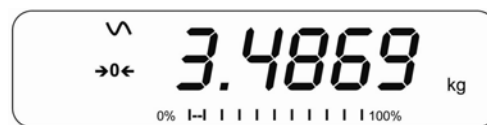

- Continue until all weights have been added. This can continue for up to 99 entries until the capacity of display is exceeded.
- To view the total in memory press the **[Print]** key when the indicator is at zero. The display will show the total number of accumulation "ACC xx" and the total weight before returning to zero.
- To print the total, press **[Print]** to recall and then immediately press **[Print]** the second time to print the results.
- To erase the memory, press **[Print]** to view the total and then immediately press **[CE]** to clear the memory.



## 11.9.2 AUTOMATIC ACCUMULATION

When the indicator has been set to Automatic Accumulation the value is stored in memory automatically.

- Place a weight on the platform. The beeper will sound when the display is stable indicating the value is accepted. Remove the weight.
- The display will show "**ACC 1**" and then the total in the memory before it returns to zero. Adding a 2nd weight will repeat the process.
- While the weight is on the platform, press the **[Print]** key to view the values- first the accumulation number "**ACC x**" and then the total will be shown.

### **NOTE:**

1. The indicator will not show the value when a weight is removed.
2. In all cases the display must return to zero or a negative number, before another sample can be added to the memory.
3. More products can be added and **[Print]** be pressed again for up to 99 entries until the capacity of display is exceeded.

## 12. RS-232 SPECIFICATION

The GK indicator is supplied with bi-directional RS-232 interface as standard. The indicator when connected to a printer or computer outputs the weight with the selected weighing unit through the RS-232 interface.

Default Specifications:

RS-232 output of weighing data
ASCII code
9600 Baud (user selectable)
8 data bits
No Parity

Connector:

9 pin d-sub miniature socket
Pin 3 Output
Pin 2 Input
Pin 5 Signal Ground

The indicator can be set to print text in English, French, German or Spanish. See the RS-232 parameters section for details.

### Data Format-Normal Output:

Only weight value along with the weighing unit is printed. If Percent weighing is used then % is shown in place of weighing units.

```
<cr><lf>
<cr><lf>
Date          12/09/2006 <cr><lf>
Time          14:56:27  <cr><lf>
<cr><lf>
Scale ID      123456    <cr><lf>    If ID is zero, it is left blank
User ID      234567    <cr><lf>
<cr><lf>
Net Wt       1.234 kg  <cr><lf>    Net Wt. (or Gross Wt.)
<cr><lf>
<cr><lf>
<cr><lf>
<cr><lf>
```

### Data Format-Parts Counting Output:

Weight, Unit weight and number of parts are printed.

```
<cr><lf>
<cr><lf>
Date          12/09/2006 <cr><lf>
Time          14:56:27  <cr><lf>
<cr><lf>
Scale ID      123456    <cr><lf>
User ID      234567    <cr><lf>
<cr><lf>
Net Wt.       1.234 kg  <cr><lf>    Net Wt. (or Gross Wt.)
Unit Wt.      123 g    <cr><lf>    g    for metric and lb for pounds
PCS           10 pcs  <cr><lf>
<cr><lf>
<cr><lf>
```

## Data Format- Memory Recall Output:

```
<cr><lf>
Date          12/09/2006 <cr><lf>
Time          14:56:27   <cr><lf>
<cr><lf>
Scale ID      123456     <cr><lf>
User ID       234567     <cr><lf>
<cr><lf>
-----<cr><lf>
TOTAL
No.           5          <cr><lf>
Wt.           1.234 kg   <cr><lf>
PCS           10 pcs    <cr><lf>
<cr><lf>
-----<cr><lf>
<cr><lf>
```

### Data Format- Continuous Output- Normal weighing:

```
Net      1.234 kg <cr><lf>          Net Weight (or Gross wt.)
<cr><lf>
<cr><lf>
```

### Data Format- Continuous Output- Parts Counting:

```
Net      1.234 kg <cr><lf>          Net Weight (or Gross wt.)
U.W.     123 g   <cr><lf>          kg and g for metric and Lb for pounds
PCS      10 pcs <cr><lf>
<cr><lf>
<cr><lf>
```

**NOTE:**

1. The accumulated total will not be sent to the RS-232 when the continuous print is turned on.
2. The continuous print will only be for the current weight and the display data.
3. In other languages the format is the same but the text will be in the language selected.
4. When the scale is in the Lb:oz weighing unit the RS-232 output will only show pounds. 10lb:8oz will be printed as 10.5 lb.

<b>Description</b>	<b>ENGLISH</b>	<b>FRENCH</b>	<b>GERMAN</b>	<b>SPANISH</b>
Net weight	<b>Net Wt.</b>	<b>Pds Net</b>	<b>Net-Gew</b>	<b>Pso Net</b>
Weight per unit counted	<b>Unit Wt.</b>	<b>Pds unit</b>	<b>Gew/Einh</b>	<b>Pso/Unid</b>
Number of items counted	<b>Pcs</b>	<b>Pcs</b>	<b>Stck.</b>	<b>Piezas</b>
Number of weighing added to subtotals	<b>No.</b>	<b>Nb.</b>	<b>Anzhl</b>	<b>Num.</b>
Total weight and count printed	<b>Total</b>	<b>Total</b>	<b>Gesamt</b>	<b>Total</b>
Print date	<b>Date</b>	<b>Date</b>	<b>Datum</b>	<b>Fecha</b>
Print time	<b>Time</b>	<b>Heure</b>	<b>Zeit</b>	<b>Hora</b>
Scale ID number	<b>Scale ID</b>	<b>Bal ID</b>	<b>Waagen ID</b>	<b>Bal ID</b>
User ID Number	<b>User ID</b>	<b>Util ID</b>	<b>Nutzer ID</b>	<b>Usuario ID</b>

## 12.1. INPUT COMMANDS FORMAT

The indicator can be controlled with the following commands. Press the **[Enter]** key of the PC after each command.

**T<cr><lf>** Tares the indicator to display the net weight. This is the same as pressing **[Tare]**.

**Z<cr><lf>** Sets the zero point for all subsequent weighing. The display shows zero.

**P<cr><lf>** Prints the results to a PC or printer using the RS-232 interface. It also adds the value to the accumulation memory if the accumulation function is not set to automatic.

## 13. CALIBRATION

- The GK indicator can be calibrated using kilogram weights or using pounds weights, depending on the weighing unit selected at the time of calibration.
- To start the calibration, either get into the calibration section through the Indicator Settings ("**FUnC 3**"- see Section 13.3) or turn the indicator off and switch on again and then press [**Tare**] during the self-test. Enter code number 0000 and press [**Tare**]. This will take you directly to the calibration section.
- The display will show "**UnLoAd**"
- Remove all weight from the platform and then press the [**Tare**] key when the display is stable. After the Zero point is set, the display will show "**Ld xx**". Place the suggested calibration mass on the platform. It is best to use a weight close to the full capacity of the indicator. If the mass is different from the displayed value, enter the value of the mass in whole numbers. The kg or the lb symbol will be on to show the active unit.
- Press the [**Tare**] key when the stable indicator is on.
- The indicator will calibrate to the mass. When complete, it will display "**PASS**" and then either display "**S8 CAL**" (if entered the calibration section through the Indicator Settings as per section 13.3) or return to normal weighing (if entered directly). Remove the calibration mass.
- If an error message "**FAIL H**" or "**FAIL L**" is shown, re-check the calibration and repeat. If the error cannot be corrected contact your supplier.



## 14. PARAMETER SETTINGS

Pressing the **[Func]** key allows the user to access the parameters for customising the indicator. The parameters are split into 4 groups-

1. Check weighing parameters,
2. RS-232 parameters
3. Indicator parameters
4. Percent and Animal Weighing Functions

- When **[Func]** is pressed, display will first show **"Func 1"** for Check weighing parameters.
- Enter **[2]** for RS-232 parameters or **[3]** for Indicator parameters or **[4]** for percent weighing and animal weighing, or press the **[Func]** key to advance through the groups **"Func 1"**, **"Func 2"**, **"Func 3"** and **"Func 4"**. Press **[Tare]** to enter the desired group of parameters.
- Press **[Zero]** to return to the group **"Func 1"**. If you press **[Zero]** again, the indicator will exit the User Parameter section and return to normal weighing.

### 14.1. CHECK WEIGHING PARAMETERS

- Shortcut to enter this group is to press and hold the **[Unit]** key for 4 seconds. The display will go directly to **"Func 1"**.
- Press **[Tare]** to enter the group.
- Press **[Func]** to scroll through the parameters and press **[Tare]** to enter a parameter setting.

- Press [**Func**] to view the options for setting.
- Press [**Tare**] to confirm the change and then advance to the next parameter by pressing the [**Func**] key.

This group of parameters-

- enables or disables the percent weighing
- sets the lock for re-setting the check weighing limits
- enables or disables the check weighing LED indicator
- enables or disables the check weighing alarm
- sets the User Password for check weighing
- enables or disables the negative check weighing

Parameter	Description	Options	Default setting
<b>F1 LLk</b>	This parameter prevents the normal user from changing the limits with the help of a Limit Lock.	<p>With LLK set to Off (oFF), the user is allowed to change limits at any time.</p> <p>With LLK set to Preset (PSt), the user is allowed to use one of the preset limits only.</p>	<b>oFF</b>

<b>F2 LED</b>	This parameter sets the LED indicator to off or on and the LED type (whether LED's are on in the form of a continuous bar or a spot LED or a segment of colour).	<b>bAr</b> - Bar type <b>Spot</b> - Spot type <b>Seg</b> - Segment <b>oFF</b> - Off	<b>bAr</b>
<b>F3 bEP</b>	This parameter sets the Beeper to off or on. If set to on, the beeper can further be set to sound when the weighing result is within or outside the check-weighing limits.	<b>bP oFF</b> - Off <b>bP inL</b> - Within limits <b>bP otL</b> - Outside limits (>20d)	<b>bP inL</b>
<b>F4 CPS</b>	This parameter allows setting of a new Check weighing password, must be entered twice when asked. When complete, it will display " <b>donE</b> ".	To be entered manually.	<b>0000</b>
<b>F5 nCK</b>	This parameter enables negative check weighing function with ability to do negative tare.	<b>on</b> <b>oFF</b>	<b>on</b>

**NOTE:**

1. The Check weighing password is separate from the indicator password, see section 13.3.
2. If the password is other than 0000, user must enter the password to gain access to "**F3 LLk**", "**F4 LED**", "**F5 bEP**", "**F6 CPS**" and "**F7 nCK**".

## 14.2. RS-232 PARAMETERS

- Shortcut to enter this group is to press and hold the **[Print]** key for 4 seconds. The display will go directly to "**C1 on**".
- Press **[Func]** to view the list of parameters.
- Press **[Tare]** to enter a parameter. Press **[Func]** to view the options for the parameter settings.
- Press **[Tare]** to confirm the change and then advance to the next parameter by pressing the **[Func]** key.
- Press **[Zero]** to return to the group "**FUnC 2**". If you press **[Zero]** again, the indicator will exit the User Parameter section and return to weighing.

This group of parameters can be set by the user for setting the language, baud rate, printing mode, etc. The user can also set a Scale ID number and a User ID number.

Parameter	Description	Options	Default Values or setting
<b>C1 on</b>	Enable or disable the RS-232 interface	<b>Prt on</b> <b>Prt oFF</b>	<b>Prt on</b>
<b>C2 bd</b>	Baud Rate	<b>600</b> <b>1200</b> <b>2400</b> <b>4800</b> <b>9600</b> <b>19200</b>	<b>9600</b>

<b>C3 PrM</b>	Printing Mode- Manual, Continuous or Automatic	<b>mAn</b> , <b>Cont</b> (not on EC approved scales) <b>AUto</b>	<b>mAn</b>
<b>C4 Aon</b>	Enable or disable the Accumulation	<b>AC on</b> <b>AC oFF</b>	<b>AC on</b>
<b>C5 Ln</b>	Select Language	<b>EnGLi</b> (English) <b>FrEnCH</b> (French) <b>GErmAn</b> (German) <b>SPAn</b> (Spanish)	<b>EnGLi</b>
<b>C6 Uld</b>	Set User ID	To be entered manually	<b>000000</b>
<b>C7 Sid</b>	Set Scale ID	To be entered manually	<b>000000</b>

The indicator will perform the following, depending on the Accumulation and Print Settings:

	<b>ACCUMULATION SETTINGS</b>	<b>AC on</b>	<b>AC Off</b>
	<b>PRINT SETTINGS</b>		
<b>AUto</b>		Accumulate and print automatically	Print automatically, Do not accumulate
<b>mAn</b>		Accumulate and Print only when <b>[Print]</b> key pressed	Print when <b>[Print]</b> key is pressed, Do not accumulate.
<b>Cont</b>		Print continuously.	Print continuously.
Not available on approved indicators		Accumulate when <b>[Print]</b> key is pressed	Do not accumulate.

### 14.3. INDICATOR PARAMETERS

- Shortcut to enter this group is to press and hold the **[Count]** Key for 4 seconds. The display will go directly to “S1 Un ”.
- Press **[Func]** to view the list of parameters.
- Press **[Tare]** to enter a parameter. Press **[Func]** to view the options for the parameter settings.
- Press **[Tare]** to confirm the change and then advance to the next parameter by pressing the **[Func]** key.
- Press **[Zero]** to return to the group “**FUnC 3**”. If you press **[Zero]** again, the indicator will exit the User Parameter section and return to normal weighing.

This group of parameters are used to control the operation of the indicator.

Parameter	Description	Options	Default setting
<b>S1 Un</b>	Enable or disable weighing units, Not all units are available for all scales settings.  Only USA scales have imperial unit.	<b>kg</b> <b>g</b> <b>lb</b> <b>oz</b> <b>lb:oz</b>	<b>kg</b>
<b>S2 bL</b>	Backlight set to always on, always off or automatic on whenever a weight is placed or a key is pressed	<b>EL off</b> <b>EL on</b> <b>EL AU</b>	<b>EL AU</b>

<b>S3 AoF</b>	Auto Off- Disable or set time increment to turn off the indicator	<b>SLP 0</b> <b>SLP 1</b> <b>SLP 5</b> <b>SLP 10</b>	<b>SLP 0</b>
<b>S4 dt</b>	Set Time and Date format and settings	Enter the time manually  Enter the date manually	<b>00:00:00</b>  <b>mm:dd:yy</b>
<b>S5 diS</b>	Display all weights or only when stable	<b>ALL</b> <b>StAb</b>	<b>ALL</b>
<b>S6 Fi</b>	Filter setting to slow, normal or fast	<b>Slow</b> <b>nor</b> <b>FAST</b>	<b>nor</b>
<b>S7 SPS</b>	Scale Password- If it is anything other than 0000 then the user must enter the password to gain access to any of the indicator parameter settings. Must be entered twice when asked. When complete, it will display "donE".	<b>PI _ _ _ _</b>	<b>0000</b>
<b>S8 CAL</b>	Calibration	Calibrate the indicator to a platform. See Section 10.0	-

#### 14.4. PERCENT WEIGHING AND ANIMAL WEIGHING

See section 10.7 and 10.8 for details of these special weighing modes.

Parameter	Description	Options	Default setting
<b>F4 Pct</b>	This parameter allows the user to enter the Percent weighing Function. See Section 10.7.	None	Enabled always
<b>F4 AnL</b>	Enter the Animal Weighing mode of operation, See section 10.8	Set the filter value.	Enabled Always



## 15. ERROR MESSAGES

During the initial power-on testing or during operation, the indicator may show an error message. The meaning of the error messages is described below.

If an error message is shown, repeat the step that caused the message. If the error message is still shown then contact your dealer for support.

ERROR CODE	DESCRIPTION	POSSIBLE CAUSES
Err 1	Time input Error	Invalid time entry such as "268970" for the time format "H-m-S".
Err 2	Date input Error	34th day of a month is an invalid entry.
Err 4	Initial Zero is greater than allowed (4% of maximum capacity) when power is turned on or when the [Zero/Enter] key is pressed.	Weight on the platform when turning the indicator on.  Excessive weight on the platform when zeroing the indicator.  Platform is not installed.  Improper calibration of the indicator.  Damaged load cell.  Damaged Electronics.
Err 6	A/D count is not correct when turning the indicator on.	Load cell is damaged.  Electronics is damaged.
Err 7	Percent input error	Percent function is entered with no reference mass on the platform.
Err 8	High limit input error	Low limit is set first, then the high limit is set lower than the low limit and high limit not equal to zero.

<b>Err 9</b>	Low limit input error	High limit is set first, then the low limit is set higher than the high limit and low limit not equal to zero.
<b>FAIL H</b> or <b>FAIL L</b>	Calibration error	Improper calibration (should be within +10% of the factory calibration). The old calibration data will be retained until the calibration process is complete.

## 16. SERVICE PARAMETERS

### 16.1. ACCESS TO PARAMETERS

#### APPROVED INDICATORS

Access to the indicator parameters and calibration is controlled in all approved indicators either by limiting access to be after the Calibration Jumper is put on the PCB, location J1, pins 1 & 2. In this case the display will show the passcode request screen, "P----". To continue enter a passcode as described below.

Or if the Calibration and Parameters have been enabled (see 15.2.10) the user must enter the correct password to have access. See Section 6.0.

Entering passcode 0000 will allow calibration as shown in 15.1, entering 1000 will allow access to a limited set of parameters as described in section 6.2 and entering the passcode 2006 will allow access to all parameters as shown in section 15.2.

#### NON-APPROVED INDICATORS

Non EC Approved indicators will allow entry to the parameters if the Tare key is pressed during the power on cycle. The passwords work as above.

#### **15.1 USING "0000" TO ENTER THE CALIBRATION PARAMETER**

"Pn"	When "Pn" is displayed. Enter "0 0 0 0" and press <b>[Tare]</b>
"UnLoAd "	Empty the platform by removing the load, if there is any and press <b>[Tare]</b>
"LoAd" "6" "KiLoS"	Load the requested calibration weight and press <b>[Tare]</b>

"SPAn" "PASS"
Or, "SPAn" "FAiEd "
"JP On"

If Calibration is complete, "SPAn PASS" will be displayed. Remove the calibration weight.

This means calibration has failed. Remove the calibration weight and repeat the process.

Remove the jumper or shorting of the pins whichever is used. The indicator will return to normal weighing.

### 16.2. USING "2006" TO ENTER THE SERVICE PARAMETERS

Non-Approved indicators:

For the non approved indicator press the **[Tare]** key during the display counting when turned on,

Approved Indicators: For the Approved version a jumper can be installed to allow access or the Calibration and Parameter Counters must be enabled (see 15.2.10).

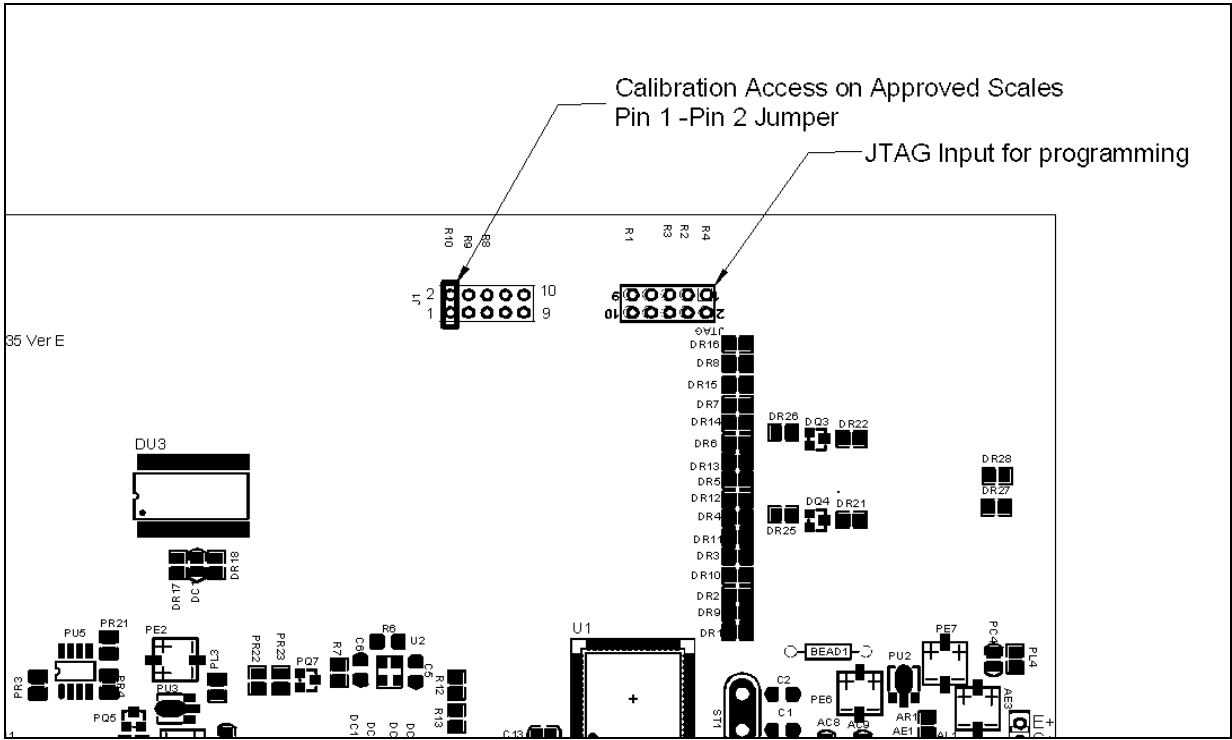

Apply power to the indicator. If the jumper has been used the display will ask for a code number, "Pn " on the Weight Display immediately. Or press the [Tare] key during the time the calibration counters are being displayed.

Enter the number 2006 when "Pn " is displayed and then press [Tare].

The displays will show the first parameters, called "F1" "CAL".

To select another parameter press the [Func] key to advance through the parameters.

Press the [Tare] key to enter a parameter.

To exit a parameter, press the [Zero] key.

The display will show the parameter number and a name.

When a parameter is entered by pressing the [Tare] key, the displays will guide you through the parameter selected and the options available.

The parameters available are:

"F1 CAL"	To enter the Calibration
"F2 dEC"	Decimal Point Position
"F3 CAP"	Default Weighing Unit
"F4 Int"	Initial Zero Range
"F5 rEZ"	Re-Zero range
"F6 SCS"	Successive Tare Enable
"F7 Cnt"	Display the A/D counts
"F8 Zem"	Zero Mode
"F9 Lvd"	Low voltage detection
"F10 Cn"	Calibration and Parameter counters

### 16.2.1 F1 -CALIBRATION

To enter the calibration parameter, press the **[Tare]** key when "**F1**" is displayed. The indicator will be calibrated using 2 masses of approximately 1/3 Maximum and Maximum. If the indicator has been calibrated once the values will be stored. If this is the first time the indicator is calibrated the user must enter the values for the calibration masses.

It is necessary to set the decimal point location and the capacity before calibration is possible.

The display will instruct you to remove any weight from the platform, "**UnloAd**". Press **[Tare]**.

The display will tell you to add the first weight to the platform: "**Ld 1**" " **10 kg**" If necessary change the value shown to match the weight to be used. Press **[CE]** to clear the old value and then enter the new value. All values entered are in whole numbers only.

Add the weight shown, wait for stability then press the **[Tare]** key.

The display will tell you to add the second weight to the platform: "**Ld 2**" " **30 kg**"

Add the weight shown, wait for stability then press the **[Tare]** key.

The display will show "**SPAn**" "**PASS**" if the calibration is OK.

Remove the weight.

For the approved indicator the display will then show "**JP**" "**On**" indicating the jumper is still in place if the jumper within the indicator was used to access the parameters..

Switch off the indicator, and switch it on again to continue with the other Service parameters.

### 16.2.2 F2–DECIMAL POINT POSITION

To set the value for the decimal point location. The options are 0, 0.0, 0.00, 0.000, 0.0000

To enter this parameter, press the **[Tare]** key when **"F2 dEC"** is shown.

The display will show the current setting.

Press the **[Func]** key to change the value. Select from 0, 0.0, 0.00, 0.000, 0.0000

Press **[Tare]** to accept the displayed value.

### 16.2.3 F3 – CAPACITY

To enter this parameter, press the **[Tare]** key when **"F3 CAP"** is shown.

The display will show the current capacity.

Enter the numeric values using the keypad. The indicator will check the number of divisions  $n = \text{maximum/increment}$  is less than 30,000 divisions. (3000 divisions for EC approved versions)

Press **[Tare]** to accept the displayed value.

On non-approved versions the display then lets you select the increment, **"InC 2"**

For example 100kg x 0.01kg the increment is 10grams. but the last digit increments by 1.

The display will show the current increment value as used with the current decimal point position.

Press the **[Func]** key to change the value. Select from 1,2,5,10, 20 or 50

Not all increments may be available for the capacity you selected.

For EC Approved versions the indicator will determine the increment that maintains the number of divisions to be 3000 or less.

Press **[Tare]** to accept the displayed value.

Press **[Zero]** to return to weighing.

#### 16.2.4 F4 –INITIAL ZERO RANGE

To enter this parameter, press the **[Tare]** key when “**F4 int**” is shown.

The display will show the current initial zero range.

Press the **[Func]** key to change the value and press **[Tare]** to accept the value.

Press **[Zero]** to return to weighing.

#### 16.2.5 F5 -RE-ZERO RANGE

To enter this parameter, press the **[Tare]** key when “**F5 rEZ**” is shown.

The display will show the current re-zero range.

Press the **[Func]** key to change the value.



Press **[Tare]** to accept the value.

Press **[Zero]** to return to weighing.

#### 16.2.6 F6 -SUCCESSIVE TARE

To enter this parameter, press the **[Tare]** key when "**F6 SCS**" is shown.

The display will show if the successive tare is on or off.

Press the **[Func]** key to change the value.

Press **[Tare]** to accept the displayed value.

Press **[Zero]** to return to weighing.

#### 16.2.7 F7 –ADC COUNTS

To enter this parameter, press the **[Tare]** key when "**F7 Cnt**" is shown.

This parameter allows you to view the A/D counts from the internal A/D converter.

This can be an aid to service.

Press the **[Tare]** key to return to the PARAMETER menu.

Press the **[Zero]** key to return to weighing.

Typical value at zero is 30,000-90,000 (approx.)

Typical value at full capacity is 500,000 (approx.)

## 16.2.8 F8 –ZERO MODE

To enter this parameter, press the **[Tare]** key when “**F8 ZEm**” is shown.

Select the Zero mode desired. In all but special cases Zero Mode 1 is used. The other 2 zero modes are for unique locations in the world and effect the +/- range of the zero.

Press the **[Func]** key to change the value.

Press **[Tare]** to accept the displayed value.

Press **[Zero]** to return to weighing.

## 16.2.9 F9 –LOW VOLTAGE DETECTION

This parameter allows detection of low voltage when the battery wears down.

To enter this parameter, press the **[Tare]** key when “**F9 LVd**” is shown.

The display will show if the LVD Mode is set to on or off.

Press the **[Func]** key to change the value.

Press **[Tare]** to accept the displayed value.

Press **[Zero]** to return to weighing.

#### 16.2.10 F10 –CALIBRATION COUNT (GK-M ONLY)

This parameter allows the calibration and parameter counting function to be active.

To enter this parameter, press the **[Tare]** key when “**F10 Cn**” is shown.

The display will show if the Calibration Counting Mode is set to on or off. If On the Calibration count and Parameter count will be seen at power on as described in section 6.0. If set to Off the only method that can be used for access to the calibration or parameters is to place the jumper on pins 1-2 of J1, See section 15.2.

Press the **[Func]** key to change the value.

Press **[Tare]** to accept the displayed value.

Press **[Zero]** to return to weighing.

#### 16.2.11 F10 –AUTO ZERO RANGE (NOT AVAILABLE ON GK-M)

This parameter set the range the autozero is active within.

To enter this parameter, press the **[Tare]** key when “**F10 Az**” is shown.

The display will show the current setting, 0.5d, 1d, 2d, or 5d.

Press the **[Func]** key to change the value.

Press **[Tare]** to accept the displayed value.

Press **[Zero]** to return to weighing.

## **17. REPLACEMENT PARTS AND ACCESSORIES**

If you need to order any spare parts and accessories, contact your supplier or Adam Equipment. A partial list of such items is as follows-

- **Main Power cord or adaptor for USA versions.**
- **Replacement Battery**
- **In use cover**
- **Printer, etc.**

## 18. SERVICE INFORMATION

This manual covers the details of operation. If you have a problem with the indicator that is not directly addressed by this manual then contact your supplier for assistance. In order to provide further assistance, the supplier will need the following information which should be kept ready:

### **A. Details of your company**

- Name of your company:
- Contact person's name:
- Contact telephone, e-mail,  
fax or any other methods:

### **B. Details of the unit purchased**

(This part of information should always be available for any future correspondence. We suggest you to fill in this form as soon as the unit is received and keep a print-out in your record for ready reference.)

Model name of the indicator: **GK**\_\_\_\_\_

Serial number of the unit:

Software revision number

(Displayed when power is first turned on):

Date of Purchase:

Name of the supplier and place:

### **C. Brief description of the problem**

Include any recent history of the unit. For example:

- Has it been working since it's delivered
- Has it been in contact with water
- Damaged from a fire
- Electrical Storms in the area
- Dropped on the floor, etc.

## WARRANTY INFORMATION

Adam Equipment offers Limited Warranty (Parts and Labour) for the components failed due to defects in materials or workmanship. Warranty starts from the date of delivery.

During the warranty period, should any repairs be necessary, the purchaser must inform its supplier or Adam Equipment Company. The company or its authorised Technician reserves the right to repair or replace the components at any of its workshops depending on the severity of the problems. However, any freight involved in sending the faulty units or parts to the service centre should be borne by the purchaser.

The warranty will cease to operate if the equipment is not returned in the original packaging and with correct documentation for a claim to be processed. All claims are at the sole discretion of Adam Equipment.

This warranty does not cover equipment where defects or poor performance is due to misuse, accidental damage, exposure to radioactive or corrosive materials, negligence, faulty installation, unauthorised modifications or attempted repair or failure to observe the requirements and recommendations as given in this User Manual.

Repairs carried out under the warranty does not extend the warranty period. Components removed during the warranty repairs become the company property.

The statutory right of the purchaser is not affected by this warranty. The terms of this warranty is governed by the UK law. For complete details on Warranty Information, see the terms and conditions of sale available on our web-site.

# 19. APPENDIX

## PARAMETER LAYOUT for GK / GFK SCALES

Press the **[Func]** key to enter Functions mode.

Key functions while in this section

**[Tare]** enter a parameter or accept the changes

**[Func]** move to next parameter or option

**[Zero]** return to previous parameter or return to weighing

FUNC 1	
Check weighing parameters	
<b>F1 LLk</b> Limit Lock	<b>oFF</b>  <b>PSt</b> (pre-set)
<b>F2 Led</b> LED display	<b>bAr</b> (Bar type)  <b>Spot</b> (spot type)  <b>SPEA</b> (whole segment)
<b>F3 bEP</b> Beeper Control	<b>bP oFF</b>  <b>bP Int</b> (Inside Limits)  <b>bP oTL</b> (Outside Limits)
<b>F4 CPS</b> Check weighing password	Enter using numeric method
<b>F5 NCK</b> Negative weighing Check	<b>On</b>  <b>Off</b>

FUNC 2	
RS-232 Parameters	
<b>C1 on</b> Enable RS-232	<b>Prt on</b> <b>Prt oFF</b>
<b>C2 bd</b> Baud Rate	<b>600</b> To <b>19200</b>
<b>C3 Prm</b> Printing Mode	<b>mAn</b> (Manual) cont (continuous) <b>AUto</b> (Automatic)
<b>C4 Aon</b> Enable Accumulation	<b>on</b> <b>oFF</b>
<b>C5 Ln</b> Language for printing	<b>English</b> <b>French</b> <b>German</b> <b>Spanish</b>
<b>C6 Uid</b> User ID	Enter using numeric keys
<b>C7 Sid</b> Scale ID	Enter using numeric keys

FUNC 3	
Scale Parameters	
<b>S1 Un</b> Units enable	<b>kg</b> <b>lb</b>
<b>S2 bL</b> Backlight	<b>EL oFF</b> <b>EL on</b> <b>EL AU</b> (Auto)
<b>S3 AoF</b> Set Auto off time (min.)	<b>SLP 0</b> <b>SLP 1</b> <b>SLP 5</b> <b>SLP 10</b>
<b>S4 dt</b> Set time and date	Set as described in manual
<b>S5 dIS</b> Display mode	<b>All</b> <b>StAb</b> (only when stable)
<b>S6 Fi</b> Set Filter	<b>SLow</b> <b>nor</b> (normal) <b>FAST</b>
<b>S7 SPS</b> Scale password	Enter using numeric keys
<b>S8 CAL</b>	Perform calibration

FUNC 4	
Scale Parameters	
<b>F4 Pct</b> Percent Weighing	Enter 100% reference weight
<b>F4 Ani</b> Animal weighing	<b>FLt 1</b> Filter setting To <b>FLt 5</b>





## WEEE 2012/19/EU

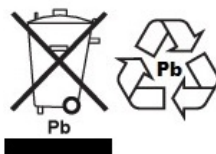

This device may not be disposed of in domestic waste. This also applies to countries outside the EU, per their specific requirements. Disposal of batteries (if fitted) must conform to local laws and restrictions.

Cet appareil ne peut être éliminé avec les déchets ménagers. L'élimination de la batterie doit être effectuée conformément aux lois et restrictions locales.

Dieses Gerät nicht mit dem Hausmüll entsorgt.

Dispositivo no puede ser desechado junto con los residuos domésticos

Dispositivo non può essere smaltito nei rifiuti domestici.

### FCC / IC CLASS A DIGITAL DEVICE EMC VERIFICATION STATEMENT

NOTE: This equipment has been tested and found to comply with the limits for a Class A digital device, pursuant to Part 15 of the FCC rules and Canadian ICES-003/NMB-003 regulation. These limits are designed to provide reasonable protection against harmful interference when the equipment is operated in a commercial environment. This equipment generates, uses and can radiate radio frequency energy and, if not installed and used in accordance with the instruction manual, may cause harmful interference to radio communications. Operation of this equipment in a residential area is likely to cause harmful interference in which case the user will be required to correct the interference at his own expense.

### CALIFORNIA PROPOSITION 65 - MANDATORY STATEMENT

WARNING: This product includes a sealed lead-acid battery which contains chemicals known to the State of California to cause cancer and birth defects or other reproductive harm.



Adam Equipment products have been tested with, and are always supplied with mains power adaptors which meet all legal requirements for the intended country or region of operation, including electrical safety, interference and energy efficiency. As we often update adaptor products to meet changing legislation it is not possible to refer to the exact model in this manual. Please contact us if you need specifications or safety information for your particular item. Do not attempt to connect or use an adaptor not supplied by us.

**ADAM EQUIPMENT** is an ISO 9001:2008 certified global company with more than 40 years' experience in the production and sale of electronic weighing equipment.

Adam products are predominantly designed for the Laboratory, Educational, Health and Fitness, Retail and Industrial Segments. The product range can be described as follows:

- Analytical and Precision Laboratory Balances
- Compact and Portable Balances
- High Capacity Balances
- Moisture analysers / balances
- Mechanical Scales
- Counting Scales
- Digital Weighing/Check-weighing Scales
- High performance Platform Scales
- Crane scales
- Mechanical and Digital Electronic Health and Fitness Scales
- Retail Scales for Price computing

For a complete listing of all Adam products visit our website at

[www.adamequipment.com](http://www.adamequipment.com)

<p><b>Adam Equipment Co. Ltd.</b> Maidstone Road, Kingston Milton Keynes MK10 0BD UK Phone:+44 (0)1908 274545 Fax: +44 (0)1908 641339 e-mail: <a href="mailto:sales@adamequipment.co.uk">sales@adamequipment.co.uk</a></p>	<p><b>Adam Equipment Inc.</b> 1, Fox Hollow Rd. 06478  USA Phone: +1 203 790 4774 Fax: +1 203 792 3406 e-mail: <a href="mailto:sales@adamequipment.com">sales@adamequipment.com</a></p>	<p><b>AE Adam GmbH.</b> Instenkamp 4 D-24242 Felde  Germany Phone +49 (0)4340 40300 0 Fax: +49 (0)4340 40300 20 e-mail: <a href="mailto:sales@adamequipment.co.za">sales@adamequipment.co.za</a></p>
<p><b>Adam Equipment S.A. (Pty) Ltd.</b> 7 Megawatt Road, Spartan EXT 22 Kempton Park, Johannesburg, Republic of South Africa  Phone +27 (0)11 974 9745 Fax: +27 (0)11 392 2587 e-mail: <a href="mailto:sales@adamequipment.co.za">sales@adamequipment.co.za</a></p>	<p><b>Adam Equipment (S.E. ASIA) PTY Ltd</b> 2/71 Tacoma Circuit CANNING VALE 6155 Perth Western Australia  Phone: +61 (0) 8 6461 6236 Fax +61 (0) 8 9456 4462 e-mail: <a href="mailto:sales@adamequipment.com.au">sales@adamequipment.com.au</a></p>	<p><b>Adam Equipment (Wuhan) Co. Ltd.</b> A Building East Jianhua Private Industrial Park Zhuanyang Avenue Wuhan Economic &amp; Technological Development Zone 430056 Wuhan P.R.China Phone: + 86 (27) 59420391 Fax + 86 (27) 59420388 e-mail: <a href="mailto:info@adamequipment.com.cn">info@adamequipment.com.cn</a></p>

© Copyright by Adam Equipment Co. All rights reserved. No part of this publication may be reprinted or translated in any form or by any means without the prior permission of Adam Equipment.

Adam Equipment reserves the right to make changes to the technology, features, specifications and design of the equipment without notice.

All information contained within this publication is to the best of our knowledge timely, complete and accurate when issued. However, we are not responsible for misinterpretations which may result from the reading of this material.

The latest version of this publication can be found on our Website.

[www.adamequipment.com](http://www.adamequipment.com)