

AZ^{extra} SERIES
(with EC type Approval)
(P.N. 6315, Rev. D, August 2017)

Software rev.: 2.29A & above

CONTENTS

1.0	INTRODUCTION	2
1.1	FEATURES.....	2
1.2	SPECIFICATIONS.....	3
2.0	INSTALLATION	3
2.1	LOCATING THE SCALES.....	3
2.2	SETTING UP THE SCALES.....	4
2.3	DISPLAY WINDOWS.....	4
2.4	BATTERY CHARGING	5
2.5	KEY DESCRIPTIONS.....	6
3.0	OPERATION.....	7
3.1	ZEROING THE DISPLAY	7
3.2	TARING	7
3.3	DETERMINING VALUE OF A PRODUCT BY WEIGHT	8
3.4	USING A STORED PLU VALUE FOR UNIT PRICE	8
3.5	ENTERING VALUES FOR THE PLU s.....	10
3.6	AUTO CLEAR KEY	11
3.7	PRICE PER KILOGRAM AND PER 100 GRAM- [Kg 100g] KEY	11
3.8	AUTO SLEEP FUNCTION	12
3.9	BACKLIGHT OPERATION	12
3.10	RS-232 INTERFACE	13
3.10.1	Input commands format	13
3.10.2	RS-232 Setup.....	13
3.11	REAL TIME CLOCK SETUP	15
4.0	ERROR CODES	16
5.0	CALIBRATION	17
5.1	CALIBRATION PROCEDURE	17
6.0	REPLACEMENT PARTS AND ACCESSORIES.....	17
7.0	SERVICE INFORMATION	18

1.0 INTRODUCTION

The **AZextra** series of digital price-computing scales are EC Type approved. These scales provide an accurate, fast and versatile method of computing price by weight.

1.1 FEATURES

- Stainless steel weighing platform
- Level indicator with adjustable levelling feet
- Colour coded, sealed keypad
- Large 3 x 6 digits backlit liquid crystal displays (LCD)
- Displays for **Weight**, **Unit Price** and **Total Price** (or Price to Pay)
- Displays on both front and back panels (Optional user display on pillar)
- Price per 100g and per kilogram (Not applicable for South Africa and Far East)
- Auto-sleep function
- Auto clear function
- Real Time Clock (RTC) and date
- RS-232 bi-directional interface
- Battery operated for portability
- 90 hours battery life when fully charged
- Up to 103 Prices (PLU) stored for easy access

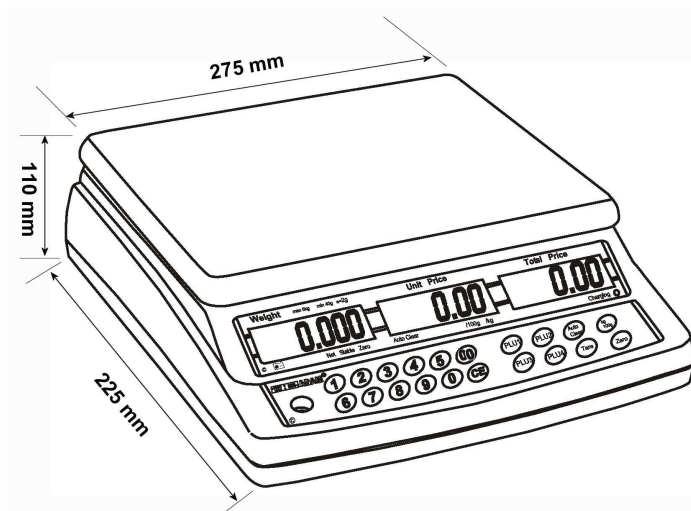



1.2 SPECIFICATIONS

	<i>AZextra</i> 3	<i>AZextra</i> 6	<i>AZextra</i> 15	<i>AZextra</i> 30	<i>AZextra</i> 3P*	<i>AZextra</i> 6P*	<i>AZextra</i> 15P*	<i>AZextra</i> 30P*
Maximum Capacity	3 kg	6 kg	15 kg	30 kg	3 kg	6 kg	15 kg	30 kg
Readability	1 g	2 g	5 g	10 g	1 g	2 g	5 g	10 g
Tare	-3 kg	-6 kg	-15 kg	-30 kg	-3 kg	-6 kg	-15 kg	-30 kg
Pan size	225 x 275 mm							
Operating Temperature	-10°C to 40°C							
Battery life	90 hours typical. Battery Life is less when the backlight is used.							
Power	Mains power supply to an internal transformer							
Interface	RS-232 bi-directional interface English, German, French, Spanish selectable text							
Date/Time	Real Time Clock (RTC), To print date and time information (Dates in year/month/day, day/month/year or month/day/year formats- Battery backed)							
Display	3 x 6 digits backlit LCD displays							
Housing	ABS Plastic with Stainless Steel Pan							
Overall Dimensions	315 x 355 x 110 mm				315 x 355 x 535 mm			
Net Weight	4.3 kg				4.7 kg			

***NOTE:** *AZextra*-P models have the Pillar Display.

2.0 INSTALLATION

2.1 LOCATING THE SCALES

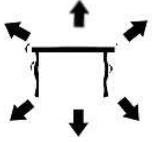
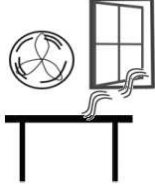
	<ul style="list-style-type: none"> The scales should not be placed in a location that will reduce the accuracy. Avoid extremes of temperature. Do not place in direct sunlight or near air conditioning vents.
	<ul style="list-style-type: none"> Avoid unsuitable tables. The table or floor must be rigid and not vibrate.
	<ul style="list-style-type: none"> Avoid unstable power sources. Do not use near large users of electricity such as welding equipment or large motors. Do not place near vibrating machinery.
	<ul style="list-style-type: none"> Avoid high humidity that might cause condensation. Avoid direct contact with water. Do not spray or immerse the scales in water. Avoid air movement such as from fans or opening doors. Do not place near open windows or air-conditioning vents. Keep the scales clean. Do not stack material on the scales when they are not in use.

2.2 SETTING UP THE SCALES

- The scales come with a stainless steel platform, packed separately.
- Place the platform in the receptacles on the top cover.
- Do not press with excessive force as that could damage the load cell inside.
- If an optional scoop has been supplied, place it on top of the platform.
- If an optional display on Pillar is supplied, install the pillar in the upright position into the socket at the rear of the scale by carefully pushing the cable inside the pillar rod. Secure the pillar rod to the socket by using two M4 screws. A black plastic cap is provided to seal the socket from the bottom to avoid damaging the cable.
- Level the scale by adjusting the four feet. The scale should be adjusted such that the bubble in the spirit level is in the centre of the level and the scale is supported by all four feet.
- Turn the power ON using the switch located on the right side of the base.
- The unit will display the software revision number in the **Weight** window and count down to zero while performing a self-test.
- When ready all three displays will show zero.

2.3 DISPLAY WINDOWS

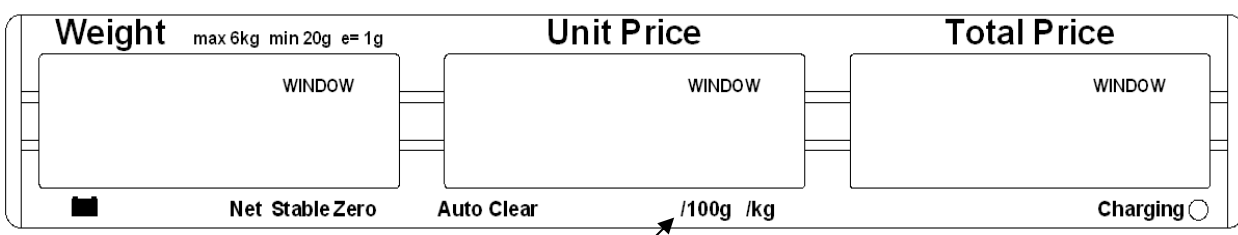

Not applicable for South Africa and Far East

The window for the **Weight** has arrows to indicate when the scale is at zero or if the scale is displaying a net weight (if a tare value has been entered). It also indicates when the scale is stable.

The window for the **Unit Price** has arrows to show when the Auto Clear function is active and if the unit price is per 100g or per kilogram.

NOTE: For South Africa and Far East, unit price per 100g or per kg is not available.

The window for the **Total Price** displays the price of the items on the scale. Below this window is a LED to show the status of the battery charging.

The above display panel is also available with French, German, Spanish, Dutch and Italian text or with symbols for Weight, Unit Price and Total Price.

2.4 BATTERY CHARGING

- The scale has an internal rechargeable lead acid battery. This battery will make the scale operate for 90 hours when fully charged or less if the backlight is on.
- When the battery needs charging the arrow above the low battery symbol  under the **Weight** window will be on and the display will show "**LO bAt**" for a few seconds and every 2 minutes as a reminder. The battery should be charged immediately. The scale will still operate for about 15 minutes after which it will automatically switch off to protect the battery from getting damaged.
- To charge the battery, simply switch the main power ON. The scale need not be turned on.
- The battery should be charged for 12 hours for full capacity.
- Just under the **Total Price** window is an LED to indicate the status of battery charging. When the scale is plugged into the main power, the internal battery will be charged. If the LED is green the battery is fully charged. If it is red the battery is nearly discharged and yellow indicates the battery should be charged longer, preferably overnight.
- If the battery has not been used properly or it is used for a number of years it may eventually fail to hold a full charge. If the battery life becomes unacceptable then contact your distributor or Adam Equipment.

2.5 KEY DESCRIPTIONS

Not applicable for South Africa and Far East

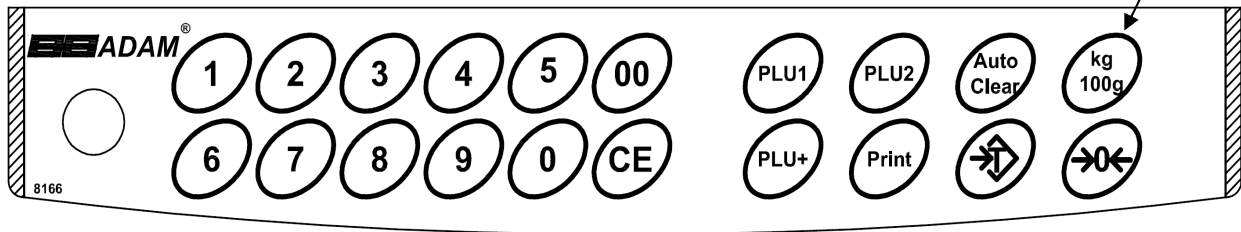

[0-9] keys

Numeric entry keys to set the unit price.

[00] key

Numeric entry keys to enter double zero values.

For example, to enter 2 pounds or Euros, press [2] and [00]. The display will show “**2.00**”.

[CE] key

Clears an erroneous entry or return to normal operation.

[PLU1] to [PLU+] keys

Stores or recalls one of the PLU values. [PLU1] and [PLU2] are to immediately recall the most used PLU values. [PLU+] is used to select any of the 99 additional values.

[Tare] or key

It tares the scale to display zero weight when an empty container is placed on the platform or removed again.

[Zero] or key

It sets the zero when the platform is empty and no tare value is entered.

[Auto Clear] key

It enables the user to automatically reset the unit price to zero, when the weight is removed.

[Kg 100g] key

It selects the unit price per kilogram or per 100g.

NOTE: For South Africa and Far East, unit price per 100g or per kg is not available.

[Print] key

It sends the results of the current displays to the RS-232 interface.

3.0 OPERATION

3.1 ZEROING THE DISPLAY

- You can press the **[Zero]** key when no tare is entered to set the zero point from which all other weighing is measured. This will usually be necessary when the platform is empty.
- When the zero point is obtained the **Weight** window will show an arrow next to the Zero legend marked under the **Weight** window.
- The scale has an automatic re-zeroing function to account for minor drifting or accumulation of material on the platform. However you may need to press **[Zero]** to re-zero the scale if small amounts of weight are shown when the platform is empty.

3.2 TARING

- Taring is used to eliminate the weight of a container so that only the net weight is displayed.
- Zero the scale by pressing **[Zero]** if necessary. The zero indicator will be on.
- Place an empty container on the platform. The weight of the container will be displayed.
- Press **[Tare]** to zero the scale. The weight that was displayed is stored as the tare value and that value is subtracted from the display, leaving zero on the display. The **Net** indicator will be on. As product is added only the weight of the product will be shown.
- When the product and container are removed the weight window will show a negative value. If a different container is to be used, remove this negative tare value by pressing the **[Tare]** once more.

3.3 DETERMINING VALUE OF A PRODUCT BY WEIGHT

- To determine the cost of a product sold by weight, it is necessary to enter the cost per kilogram or per 100g using the numeric keys or one of the preset PLU values.
- The **Weight** window will show the net weight, the **Unit Price** window will show the price per kilogram or per 100g as selected by the **[kg 100g]** key. The **Total Price** window will show the computed value for the total price.

Example:

	Display will show		
	Weight (in kg)	Unit Price	Total Price
Place a container on the scale and Press [Tare]	0.000	0.00	0.00
Place the items on the platform	1.300	0.00	0.00
Key in the unit price	1.300	5.00	6.50

- Press the **[kg 100g]** key to change the calculation to a price based on the cost per 100g or the cost per kilogram.
- If a different unit price is required either press **[CE]** to reset the unit price to 0.00 or simply enter a new unit price.

NOTE: For South Africa and Far East, unit weight per 100g or per kg is not available.

3.4 USING A STORED PLU VALUE FOR UNIT PRICE

Product Look-Up (PLU) numbers are used to store information about the most commonly used items. Using *AZextra*, the PLU values can be stored as either cost per kilogram or cost per 100g. During the weighing operation, the user can recall the cost per kilogram or per 100g of a particular item very easily using the PLU values.

NOTE: For South Africa and Far East, unit price per 100g or per kg is not available.

The individual PLU values should be entered against specific items before the weighing process starts so that the desired PLU's can be recalled during the weighing process.

The user can store and recall up to 103 PLU values as PLU1, PLU2, PLU3 and PLU00 to PLU99.

The keys labelled **[PLU1]** and **[PLU2]** are used to immediately recall the most frequently used PLU values saved as PLU1 and PLU2. The **[PLU+]** key is used to access the other values saved as PLU3 and PLU00 to PLU99.

To recall one of these PLU values the following procedure applies.

1. To recall PLU1, simply press **[PLU1]**.
2. The same applies to PLU2, simply press **[PLU2]**.
3. To recall one of the other PLU values, press **[PLU+]**. The display will show "**LOAD**" "**PoS 00**" " ". If a number (00 to 99) is entered immediately, then the value saved against the entered PLU number will be recalled. If nothing is entered within a few seconds of pressing the **[PLU+]** key, the value saved for PLU3 will be recalled.

For example:

Press **[PLU+]**.

Press **[1]** and then **[4]** immediately.

Display will show "**LOAD**" "**PoS 14**" " " and then the PLU value for PLU 14 will be displayed.

OR

Press **[PLU+]**.

Wait for few seconds.

Display will show "**LOAD**" "**PoS 00**" " " and then the PLU value for PLU 3 will be displayed.

If the item is loaded on the pan, the **Total Price** window will show the total cost. If nothing is loaded, only the PLU value saved for the location will be displayed in the **Unit Price** window and the **Total Price** window will display "**0,00**".

3.5 ENTERING VALUES FOR THE PLU s

To store values for the PLUs into the memory follow the procedure.

Entering values for PLU1 and PLU2 keys

- Enter the unit price value using the keypad, selecting either price/kg or price/100g if needed.
- Press and hold down the key **[PLU1]** or **[PLU2]** for more than 3 seconds till a beep is heard, then release the key. The scale displays **"PLU" " 1" "SAVEd"** or **"PLU" " 2" "SAVEd"**, followed by the PLU value displayed in the **Unit Price** window.

Entering values for the [PLU+] key

- Enter the unit price value using the keypad, selecting either price/kg or price/100g if needed.
- Press and hold down the key **[PLU+]** for more than 3 seconds till a beep is heard, then release the key. It will show **"SAVE" "PoS 00" " "**.
- If no number is entered for **"00"** within a few seconds, the PLU entered will be saved for position 3 which can be recalled in future by using the **[PLU+]** key. The display will show **"PLU" " 3" "SAVEd"** and the scale will return to weighing.

OR

- Enter any number (00 up to 99) for saving the unit price in the desired position. For example, press **[1]** and **[4]** for the position 14. It will show **"PLU" "14" "SAVEd "** before returning to weighing.
- To change the earlier saved value against a particular PLU, simply repeat the process.

3.6 AUTO CLEAR KEY

- The [**Auto Clear**] key will enable the Auto Clear function.
- When this function is active the scale will automatically clear (set to zero) the unit price when the last item to be weighed has been removed from the scale.
- When the Auto Clear is active the Auto Clear indicator (arrow) on the LCD will be ON.
- Pressing [**Auto Clear**] will turn off the function and the indicator will disappear. Pressing it will turn the function to on again.

3.7 PRICE PER KILOGRAM AND PER 100 GRAM- [Kg 100g] KEY

- The [**kg 100g**] key will change the scale from using a price per kilogram to price per 100g.
- It will also change the arrows under the **Unit Price** window to show the selection.
- This information is also saved for the PLU values that are stored in the memory.

NOTE: This is not applicable for AZ_{extra} for South Africa and Far East.

3.8 AUTO SLEEP FUNCTION

This function may be enabled or disabled by the user. If enabled, when the scale is not used for some time (as pre-set by the user under this function) it automatically switches off. To set this parameter-

- During self-checking, press [**Zero**] and release at once. The display shows "**SLEEP mode**".
- Press [**Print**] key to scroll through the auto sleep values.
 - "**0**" Auto sleep mode disabled
 - "**1**" Auto sleep after 1 minute
 - "**5**" Auto sleep after 5 minutes
 - "**10**" Auto sleep after 10 minutes
- Press [**Tare**] to set the value. The scale returns to zero.

3.9 BACKLIGHT OPERATION

The backlight may be enabled or disabled by the user. If the backlight is disabled the battery life will be maximised. With the backlight in operation the battery life will be less depending on the extent at which the scale is used.

To set the backlight

- Press and hold the [**Auto Clear**] key for 4 seconds.
- Press the [**Print**] key to change the operation:
 - "**EL**" "**AU**" Automatic control of the backlight
 - "**EL**" "**on**" Backlight on full time
 - "**EL**" "**off**" Backlight turned off
- Press [**Tare**] to store the setting.

Backlight operation

When the backlight is set from automatic control-

- It will only turn on when the scale is being used.
- It will be on when a weight is on the platform or when a key is pressed.
- It will turn off automatically after a few seconds when the weight is zero or after a while, the last key was pressed.

3.10 RS-232 INTERFACE

The AZ_{extra} scales include a bi-directional RS-232 interface. When connected to a printer or computer, the scale outputs the weighing results using the RS-232 interface. The scale can be controlled sending commands from a PC. See section 3.10.1.

Specifications:

RS-232 output of weighing data ASCII code Adjustable Baud rate, 600, 1200, 2400, 4800 , 9600 and 19200 baud 8 data bits No Parity

Connector:

9 pin D-subminiature socket Pin 3 Output Pin 2 Input Pin 5 Signal Ground

3.10.1 Input commands format

The scale can be controlled with the following commands. The commands must be sent in upper case letters, i.e. “**T**” not “**t**”.

T<cr><lf>	Tares the scale to display the net weight. This is the same as pressing [Tare] key.
Z<cr><lf>	Sets the zero point for all subsequent weighing. The display shows zero.
P<cr><lf>	Prints the results to a PC or printer using the RS-232 interface.

3.10.2 RS-232 Setup

The RS-232 interface uses parameters set by the user for language, currency symbol, baud rate, date format and label format of the printout. Press and hold the [**Print**] key for 4 seconds to access the parameters. Press [**Print**] to scroll through the options and [**Tare**] to confirm the change and then advance to the next parameter. When a parameter is entered by pressing [**Tare**], the

displays will guide you through the parameter selected and the options available. The parameters and their function are:

Displays			Options	Functions
Weight	Unit Price	Total Price		
Port	on		on or off	Enable or disable the RS-232 interface.
4800	bPS		600, 1200, 2400, 4800, 9600 or 19200	Set baud rate.
LABEL	1		1, 2 or 3	Select label format to print.
CoUntr	Y E	nGLiSH	EnGLiSH, FrEnCH, GErMAN or SPAniSH	Select Language to be printed.
StErLi	nG		EUroPE, dOLLAr, StErLinG	Select currency- Euro, Dollar or Pounds Sterling

LABEL FORMATS:

(NOTE: All lines are terminated with a <cr><lf>)

Label 1 (English with £ shown):

2017/08/31 13:01:56			
	UNIT PRICE	NET	TOTAL

£	1.20/100g	0.200kg	£ 2.40

Label 2 (Spanish with \$ shown):

FECHA	2017/04/08
HORA	04:00:30
PRECIO	
UNIT. \$	10.99/100g
NETO	0.200kg
TOTAL \$	21.98

Label 3 (Weight only):

+ 0.200kg

3.11 REAL TIME CLOCK SETUP

The Real Time Clock (RTC) is used only for the RS-232 output. The Date and Time can be set as required. The scale will keep the clock running even when the power is off.

Setting up the clock

- Press and hold the **[CE]** key when power is first turned on, release the key when the revision is displayed. The displays show the current date and time set.

“ rtc “ “11,14,17” “16,41,35”

- Press the **[CE]** key to change the date and time. The display will show the current time format, **“H-m-S”**.
- Enter the time using the numeric keys using a 24 hour clock format, 3:41PM is **“154100”**.
- Press the **[Tare]** key to accept the time. The display will show the current date format.
- Press the **[Print]** key to change the date format. Available formats are:

“Y-m-d” year, month, day

“m-d-Y” month, day, year

“d-m-Y” day, month, year

- Press the **[Tare]** key to accept the chosen format and then enter the date in this format.
- Press the **[Tare]** key to accept the date.

An error code will be shown if the time (**Err 1**) or the date (**Err 2**) is not the permissible values. For example, 34th day of a month is an invalid entry.

4.0 ERROR CODES

During the initial power-on testing or during operation, the scale may show an error message. If an error message is shown, repeat the step that caused the message. If the error is still shown contact your dealer for further support.

ERROR	DESCRIPTION	POSSIBLE CAUSES
Err 1	Time input error.	Tried to set an illegal time, i.e. 26 hours
Err 2	Date input error	Tried to set an illegal date, i.e. 36 th day
Err 4	Initial Zero is greater than allowed (typically 4% of the maximum capacity) when power is turned on or when [Zero] is pressed,	Weight is on the pan when turning the scale on. Excessive weight on the pan when zeroing scale. Improper calibration of the scale. Damaged load cell. Damaged Electronics.
Err 6	A/D count is not correct when turning the scale on.	Platform is not installed. Load cell is damaged. Electronics is damaged.

5.0 CALIBRATION

5.1 CALIBRATION PROCEDURE

The scales are sealed to prevent unauthorised calibration.

Contact Adam Equipment or your supplier for more details.

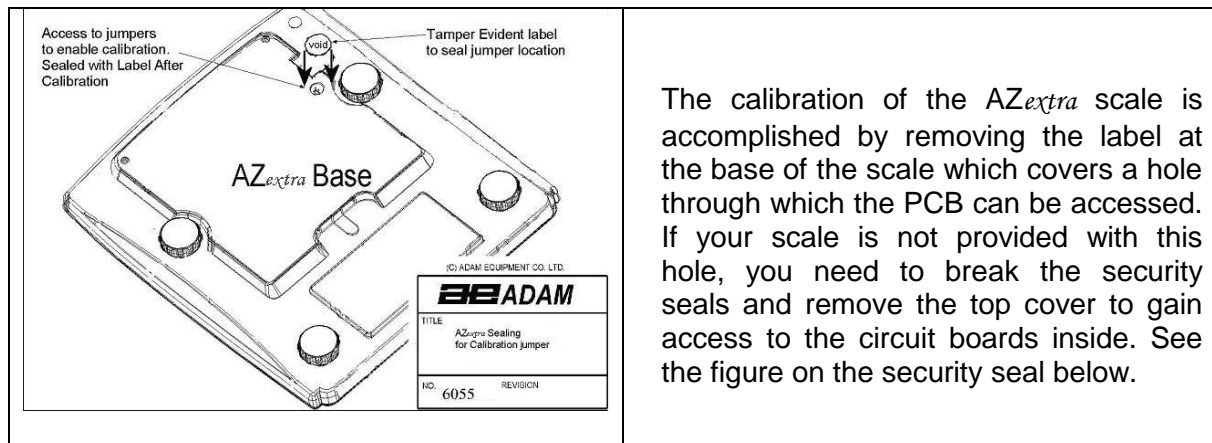

The calibration of the AZextra scale is accomplished by removing the label at the base of the scale which covers a hole through which the PCB can be accessed. If your scale is not provided with this hole, you need to break the security seals and remove the top cover to gain access to the circuit boards inside. See the figure on the security seal below.

WARNING: CALIBRATION OF THE SCALES MAY MAKE IT ILLEGAL TO USE THE SCALES FOR SALES OF GOODS. CONTACT YOUR TRADING STANDARDS OFFICE FOR FURTHER ASSISTANCE.

6.0 REPLACEMENT PARTS AND ACCESSORIES

If you need to order any spare parts and accessories, contact your supplier or Adam Equipment. A partial list of such items is as follows-

- Main Power cord
- In use cover
- Replacement Battery
- Stainless Steel Pan

7.0 SERVICE INFORMATION

This manual covers the details of operation. If you have a problem with the scale that is not directly addressed by this manual then contact your supplier for assistance. In order to provide further assistance, the supplier will need the following information which should be kept ready:

A. Details of your company
-Name of your company:
-Contact person's name:
-Contact telephone, e-mail,
fax or any other methods:

B. Details of the unit purchased
(This part of information should always be available for any future correspondence. We suggest you to fill in this form as soon as the unit is received and keep a print-out in your record for ready reference.)

Model name of the scale:	
Serial number of the unit:	
Software revision number (Displayed when power is first turned on):	
Date of Purchase:	
Name of the supplier and place:	

C. Brief description of the problem
Include any recent history of the unit. For example:
-Has it been working since it's delivered
-Has it been in contact with water
-Damaged from a fire
-Electrical Storms in the area
-Dropped on the floor, etc.

WARRANTY STATEMENT

Adam Equipment offers Limited Warranty (Parts and Labour) for any components that fail due to defects in materials or workmanship. Warranty starts from the date of delivery.

During the warranty period, should any repairs be necessary, the purchaser must inform its supplier or Adam Equipment Company. The company or its authorised Technician reserves the right to repair or replace the components at any of its workshops at no additional cost, depending on the severity of the problems. However, any freight involved in sending the faulty units or parts to the Service Centre should be borne by the purchaser.

The warranty will cease to operate if the equipment is not returned in the original packaging and with correct documentation for a claim to be processed. All claims are at the sole discretion of Adam Equipment.

This warranty does not cover equipment where defects or poor performance is due to misuse, accidental damage, exposure to radioactive or corrosive materials, negligence, faulty installation, unauthorised modifications or attempted repair, or failure to observe the requirements and recommendations as given in this User Manual.

This product may include a rechargeable battery that is designed to be removed and replaced by the user. Adam Equipment warrants that it will provide a replacement battery if the battery manifests a defect in materials or workmanship during the initial period of use of the product in which the battery is installed.

As with all batteries, the maximum capacity of any battery included in the product will decrease with time or use, and battery cycle life will vary depending on product model, configuration, features, use, and power management settings. A decrease in maximum battery capacity or battery cycle life is not a defect in materials or workmanship, and is not covered by this Limited Warranty.

Repairs carried out under the warranty do not extend the warranty period. Components removed during warranty repairs become company property.

The statutory rights of the purchaser are not affected by this warranty. The terms of this warranty is governed by the UK law. For complete details on Warranty Information, see the terms and conditions of sale available on our web-site.

WEEE 2012/19/EU

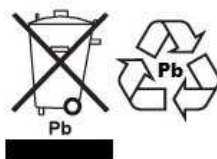

This device may not be disposed of in domestic waste. This also applies to countries outside the EU, per their specific requirements. Disposal of batteries (if fitted) must conform to local laws and restrictions.

Cet appareil ne peut être éliminé avec les déchets ménagers. L'élimination de la batterie doit être effectuée conformément aux lois et restrictions locales.

Dieses Gerät nicht mit dem Hausmüll entsorgt.

Dispositivo no puede ser desechado junto con los residuos domésticos

Dispositivo non può essere smaltito nei rifiuti domestici.

FCC / IC CLASS A DIGITAL DEVICE EMC VERIFICATION STATEMENT

NOTE: This equipment has been tested and found to comply with the limits for a Class A digital device, pursuant to Part 15 of the FCC rules and Canadian ICES-003/NMB-003 regulation. These limits are designed to provide reasonable protection against harmful interference when the equipment is operated in a commercial environment. This equipment generates, uses and can radiate radio frequency energy and, if not installed and used in accordance with the instruction manual, may cause harmful interference to radio communications. Operation of this equipment in a residential area is likely to cause harmful interference in which case the user will be required to correct the interference at his own expense.

CALIFORNIA PROPOSITION 65 - MANDATORY STATEMENT

WARNING: This product includes a sealed lead-acid battery which contains chemicals known to the State of California to cause cancer and birth defects or other reproductive harm.



Adam Equipment products have been tested with, and are always supplied with mains power adaptors which meet all legal requirements for the intended country or region of operation, including electrical safety, interference and energy efficiency. As we often update adaptor products to meet changing legislation it is not possible to refer to the exact model in this manual. Please contact us if you need specifications or safety information for your particular item. Do not attempt to connect or use an adaptor not supplied by us.

ADAM EQUIPMENT is an ISO 9001:2008 certified global company with more than 40 years' experience in the production and sale of electronic weighing equipment.

Adam products are predominantly designed for the Laboratory, Educational, Health and Fitness, Retail and Industrial Segments. The product range can be described as follows:

- Analytical and Precision Laboratory Balances
- Compact and Portable Balances
- High Capacity Balances
- Moisture analysers / balances
- Mechanical Scales
- Counting Scales
- Digital Weighing/Check-weighing Scales
- High performance Platform Scales
- Crane scales
- Mechanical and Digital Electronic Health and Fitness Scales
- Retail Scales for Price computing

For a complete listing of all Adam products visit our website at

www.adamequipment.com

<p>Adam Equipment Co. Ltd. Maidstone Road, Kingston Milton Keynes MK10 OBD UK Phone:+44 (0)1908 274545 Fax: +44 (0)1908 641339 e-mail: sales@adamequipment.co.uk</p>	<p>Adam Equipment Inc. 1, Fox Hollow Rd. 06478 USA Phone: +1 203 790 4774 Fax: +1 203 792 3406 e-mail: sales@adamequipment.com</p>	<p>AE Adam GmbH. Instenkamp 4 D-24242 Felde Germany Phone +49 (0)4340 40300 0 Fax: +49 (0)4340 40300 20 e-mail: e-mail: vertrieb@aeadam.de</p>
<p>Adam Equipment S.A. (Pty) Ltd. 7 Megawatt Road, Spartan EXT 22 Kempton Park, Johannesburg, Republic of South Africa Phone +27 (0)11 974 9745 Fax: +27 (0)11 392 2587 e-mail: sales@adamequipment.co.za</p>	<p>Adam Equipment (S.E. ASIA) PTY Ltd 2/71 Tacoma Circuit CANNING VALE 6155 Perth Western Australia Phone: +61 (0) 8 6461 6236 Fax +61 (0) 8 9456 4462 e-mail: sales@adamequipment.com.au</p>	<p>Adam Equipment (Wuhan) Co. Ltd. A Building East Jianhua Private Industrial Park Zhuanyang Avenue Wuhan Economic & Technological Development Zone 430056 Wuhan P.R.China Phone: + 86 (27) 59420391 Fax + 86 (27) 59420388 e-mail: info@adamequipment.com.cn</p>

© Copyright by Adam Equipment Co. All rights reserved. No part of this publication may be reprinted or translated in any form or by any means without the prior permission of Adam Equipment.

Adam Equipment reserves the right to make changes to the technology, features, specifications and design of the equipment without notice.

All information contained within this publication is to the best of our knowledge timely, complete and accurate when issued. However, we are not responsible for misinterpretations which may result from the reading of this material.

The latest version of this publication can be found on our Website.

www.adamequipment.com